

ALL-TERRAIN
ATF 60-4

ISO 9001

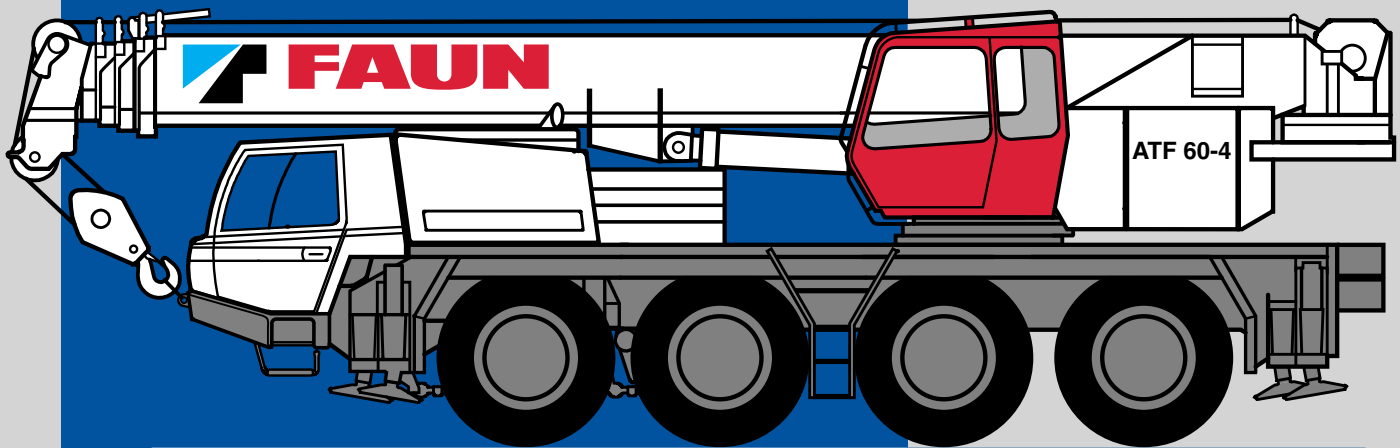

Maße / Dimensions / Dimensions / Dimensiones (mm)
 Gewichte / Weights / Poids / Pesos
 Geschwindigkeiten / Speeds / Vitesses / Velocidades

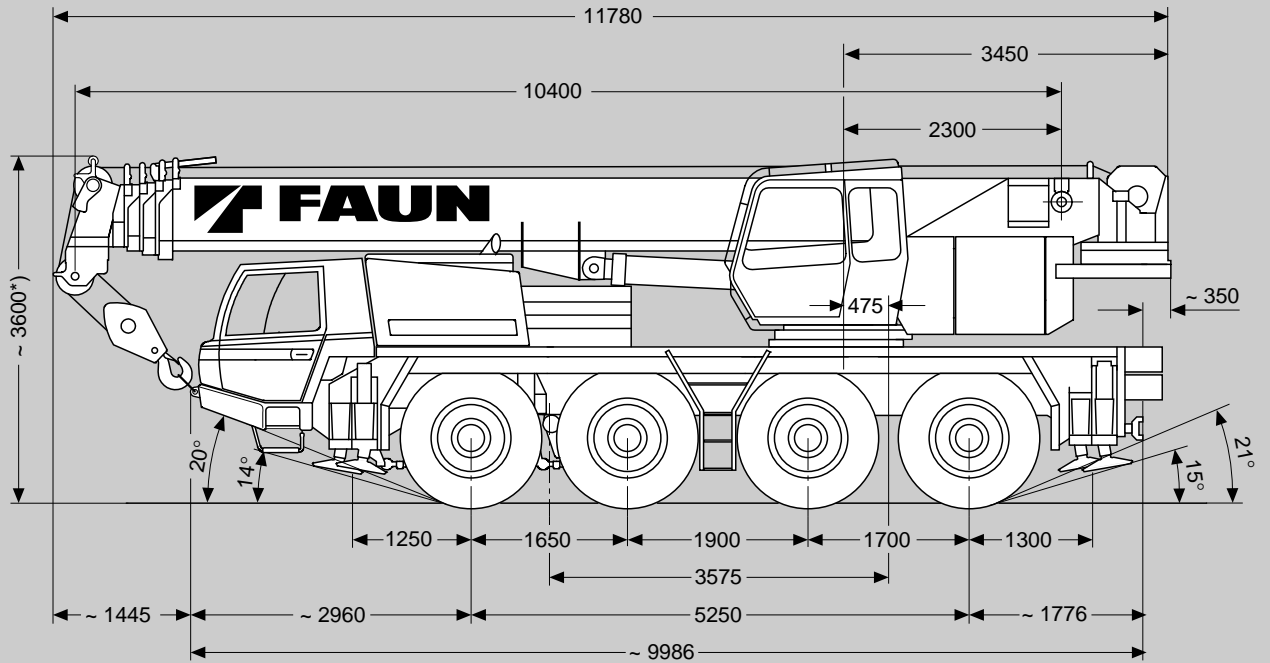
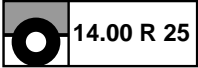

*) +/- 100 mm

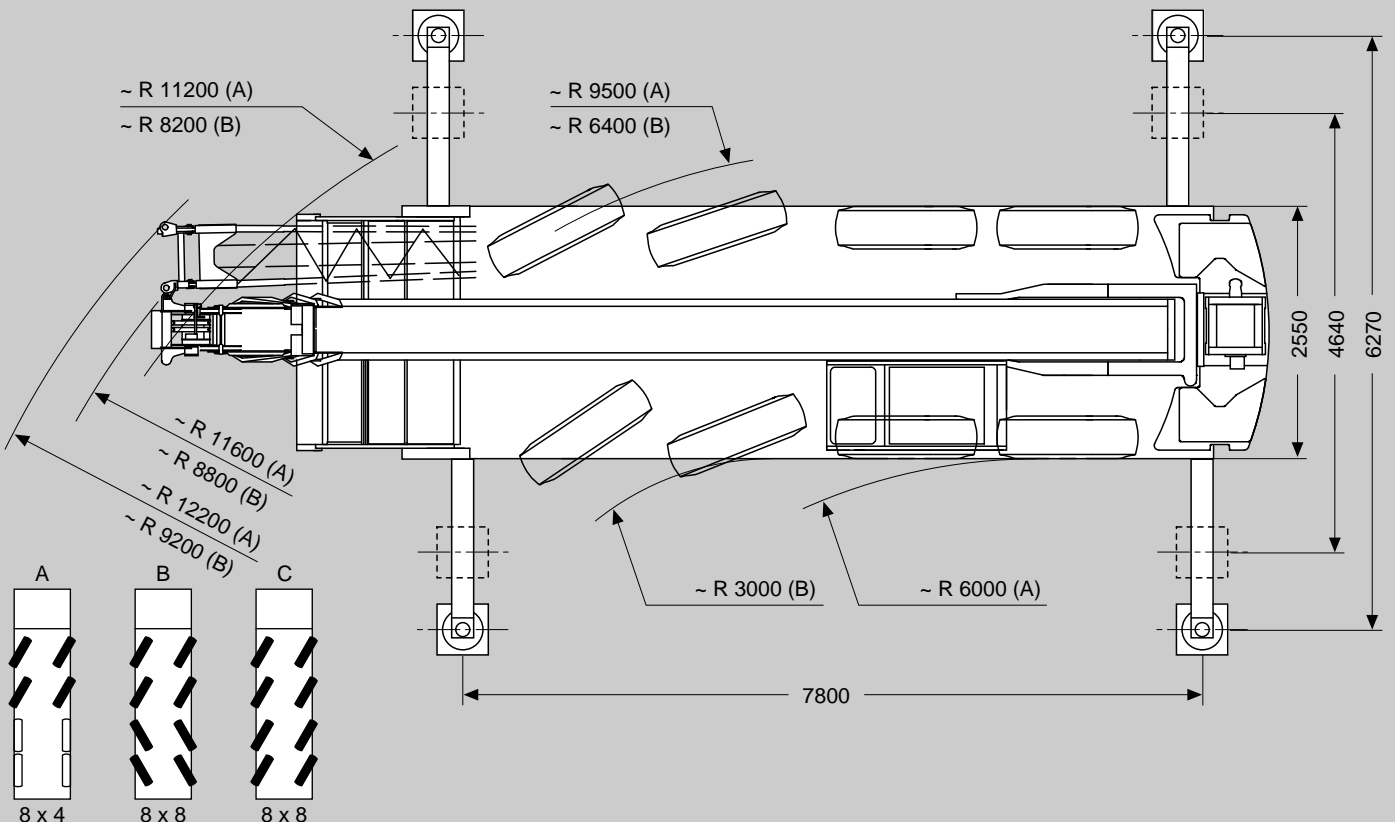

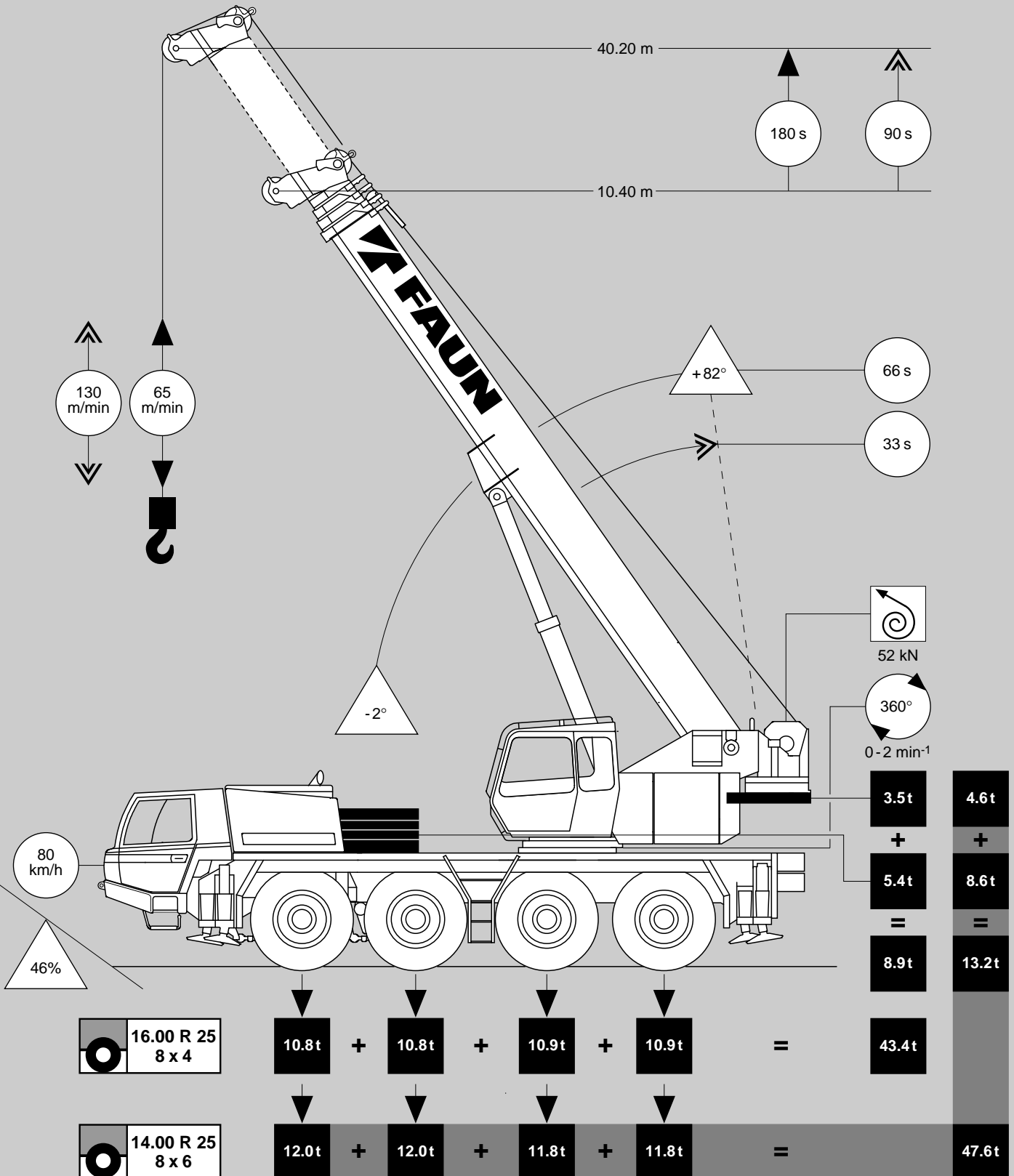

Tragfähigkeiten
Lifting capacities
Capacités de levage
Capacidades de elevación

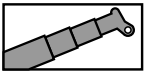

13.2t*

DIN/ISO

m	10.4 m	14.1 m	17.8 m	17.8 m	17.8 m	25.3 m	25.3 m	25.3 m	32.7 m	32.7 m	36.5 m	40.2 m
	2.5	60.0**										
3.0	50.0	30.0										
3.5	44.8	30.0	20.0	30.0	13.0							
4.0	41.0	30.0	20.0	29.0	13.0							
4.5	37.0	30.0	20.0	27.5	13.0							
5.0	34.3	30.0	20.0	26.2	13.0	13.0	17.0	11.8				
6.0	29.8	29.3	20.0	22.6	13.0	13.0	17.0	11.8	13.0	9.5		
7.0	25.3	24.9	20.0	19.8	13.0	13.0	15.8	11.8	13.0	9.2		
8.0	16.9	21.4	20.0	17.5	13.0	13.0	14.5	11.8	13.0	8.8	9.0	7.0
9.0		18.1	18.4	15.6	13.0	13.0	13.3	11.4	12.0	8.5	8.8	7.0
10.0		15.2	15.5	14.1	13.0	13.0	12.0	11.0	11.0	8.1	8.5	7.0
11.0		12.9	13.2	12.5	13.0	12.6	10.9	10.5	10.1	7.7	8.3	7.0
12.0			11.4	10.8	12.6	12.1	9.8	10.1	9.2	7.4	8.1	7.0
14.0			8.8	8.2	9.9	9.8	8.2	8.8	7.8	6.7	7.6	6.5
16.0						7.8	6.6	7.7	6.7	5.8	6.5	6.1
18.0						6.3	5.1	6.8	5.8	5.1	5.6	5.3
20.0						5.2	4.0	5.8	4.8	4.5	4.9	4.6
22.0						4.3	3.1	4.9	3.9	4.0	4.1	4.1
24.0									3.2	3.6	3.3	3.6
26.0									2.6	3.2	2.7	3.0
28.0									2.1	2.9	2.2	2.5
30.0									1.6	2.7	1.8	2.0
32.0											1.5	1.7
34.0											1.1	1.4
36.0												1.1

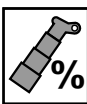

I
II
III
IV

I	0	50	50	100	0	50	100	0	100	0	100	100
II	0	0	50	0	33	50	100	67	100	100	100	100
III	0	0	0	0	33	50	0	67	50	100	75	100
IV	0	0	0	0	33	50	0	67	50	100	75	100

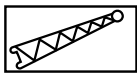
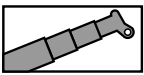

13.2t*

DIN/ISO

m	36.5 m + 9.0 m			40.2 m + 9.0 m			40.2 m + 16.0 m		
	5°	17°	30°	5°	17°	30°	5°	17°	30°
10.0	4.80			3.80					
11.0	4.80			3.80					
12.0	4.80	4.00	3.00	3.80	3.40		2.20		
14.0	4.60	3.75	2.85	3.80	3.40	2.80	2.20	1.80	
16.0	4.40	3.45	2.65	3.70	3.25	2.70	2.20	1.80	1.30
18.0	4.20	3.15	2.50	3.55	3.10	2.55	2.15	1.75	1.30
20.0	3.75	2.90	2.35	3.45	3.00	2.45	2.05	1.65	1.25
22.0	3.40	2.70	2.25	3.30	2.85	2.35	2.00	1.60	1.25
24.0	3.10	2.55	2.15	3.20	2.70	2.25	1.90	1.50	1.20
26.0	2.85	2.40	2.05	2.80	2.55	2.15	1.85	1.45	1.15
28.0	2.35	2.25	1.95	2.40	2.40	2.05	1.70	1.35	1.15
30.0	1.85	2.00	1.90	1.95	2.10	1.95	1.55	1.30	1.10
32.0	1.50	1.60	1.70	1.60	1.70	1.80	1.45	1.25	1.05
34.0	1.15	1.25	1.30	1.25	1.35	1.45	1.35	1.15	1.00
36.0	0.85	0.90	0.95	0.95	1.05	1.10	1.30	1.10	1.00
38.0	0.60	0.65	0.65	0.70	0.75	0.80	1.15	1.05	0.95
40.0		0.40	0.40	0.45	0.50	0.55	0.90	1.00	0.90
42.0							0.75	0.85	0.90
44.0							0.55	0.65	0.75
46.0								0.45	0.50

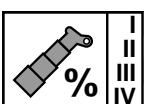

I
II
III
IV

I	100			100			100
II	100			100			100
III	75			100			100
IV	75			100			100

Hubhöhen
Lifting heights
Hauteurs de levage
Alturas de elevación

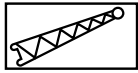
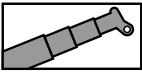

13.2t*

DIN/ISO

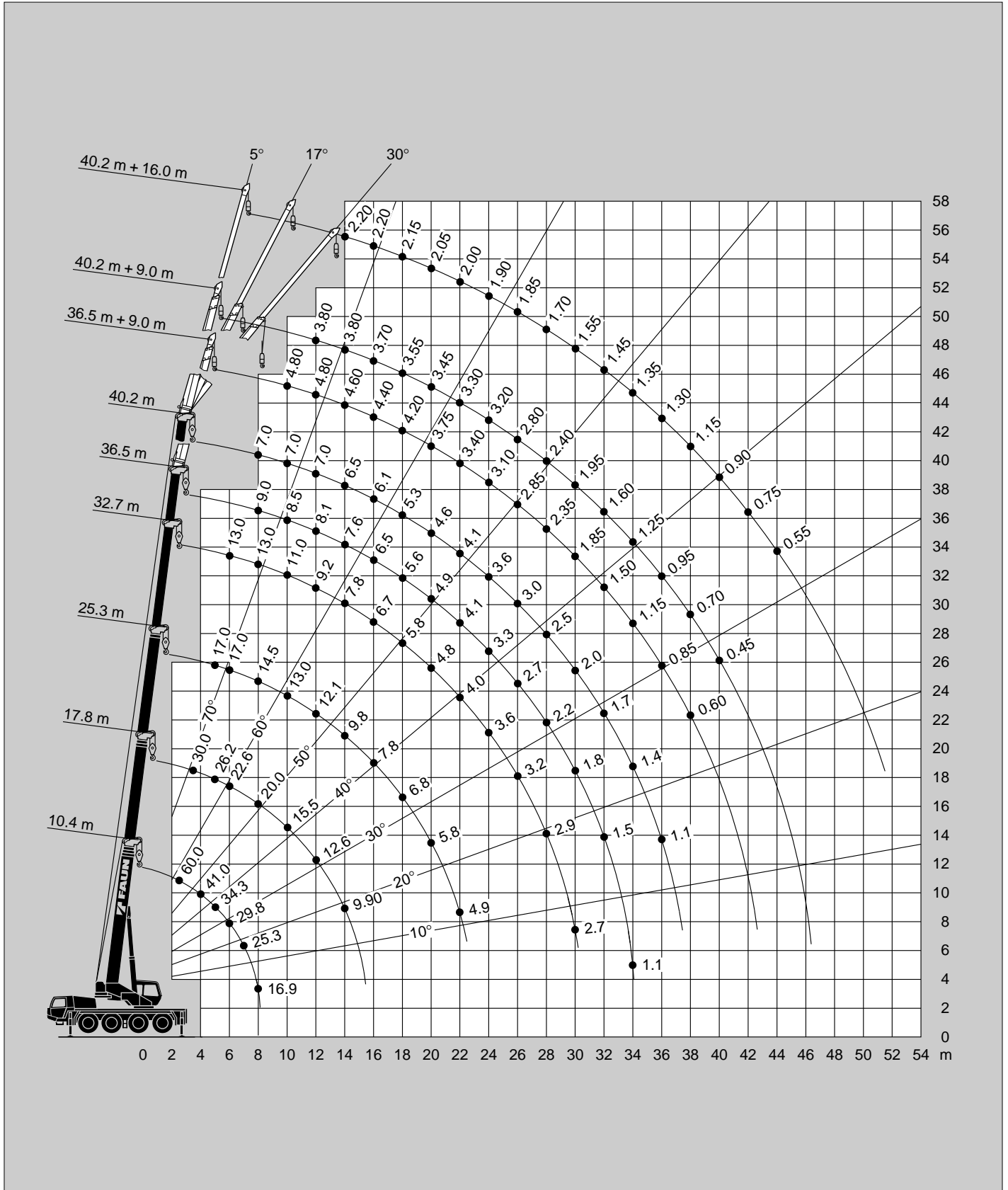

*) Gegen Mehrpreis

*) Against extra charge

*) Contre supplément de prix

*) Con suplemento de precio

**) Nach hinten, mit Zusatzausrüstung

**) Over rear, with additional equipment

**) A l'arrière, avec équipement supplémentaire

**) Sobre la parte trasera, con equipo adicional

Tragfähigkeiten
Lifting capacities
Capacités de levage
Capacidades de elevación

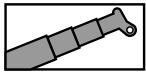

8.9t

DIN/ISO

 m	10.4 m	14.1 m	17.8 m	17.8 m	17.8 m	25.3 m	25.3 m	25.3 m	32.7 m	32.7 m	36.5 m	40.2 m
2.5	60.0**											
3.0	50.0	30.0										
3.5	44.6	30.0	20.0	30.0	13.0							
4.0	41.0	30.0	20.0	29.0	13.0							
4.5	36.8	30.0	20.0	27.5	13.0							
5.0	34.3	30.0	20.0	26.2	13.0	13.0	17.0	11.8				
6.0	29.4	27.7	20.0	22.6	13.0	13.0	17.0	11.8	13.0	9.5		
7.0	24.9	23.4	20.0	19.8	13.0	13.0	15.8	11.8	13.0	9.2		
8.0	16.9	18.8	19.1	17.5	13.0	13.0	14.5	11.8	13.0	8.8	9.0	7.0
9.0		15.3	15.6	14.9	13.0	13.0	13.3	11.4	12.0	8.5	8.8	7.0
10.0		12.7	13.0	12.3	13.0	13.0	12.0	11.0	11.0	8.1	8.5	7.0
11.0		10.7	11.0	10.3	12.3	12.1	10.6	10.5	10.1	7.7	8.3	7.0
12.0			9.4	8.7	10.6	10.4	9.0	10.1	9.2	7.4	8.1	7.0
14.0			6.9	6.3	8.1	7.9	6.6	8.6	7.5	6.7	7.5	6.5
16.0						6.2	4.9	6.8	5.7	5.8	6.0	6.1
18.0						4.9	3.7	5.5	4.5	5.1	4.7	4.9
20.0						4.0	2.8	4.6	3.5	4.5	3.8	4.0
22.0						3.2	2.0	3.8	2.8	3.9	3.0	3.2
24.0									2.2	3.3	2.4	2.6
26.0									1.7	2.8	1.8	2.0
28.0									1.2	2.3	1.4	1.6
30.0									0.9	2.0	1.0	1.2
32.0											0.7	0.9
34.0											0.5	0.7
36.0												

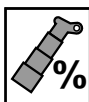

I
II
III
IV

0	50	50	100	0	50	100	0	100	0	100	0	100	100
0	0	50	0	33	50	100	67	100	100	100	100	100	100
0	0	0	0	33	50	0	67	50	100	75	100	100	100
0	0	0	0	33	50	0	67	50	100	75	100	100	100

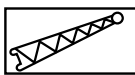
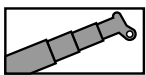

8.9t

DIN/ISO

 m	36.5 m + 9.0 m			40.2 m + 9.0 m			40.2 m + 16.0 m		
	5°	17°	30°	5°	17°	30°	5°	17°	30°
10.0	4.80			3.80					
11.0	4.80			3.80					
12.0	4.80	4.00	3.00	3.80	3.40		2.20		
14.0	4.60	3.75	2.85	3.80	3.40	2.80	2.20	1.80	
16.0	4.40	3.45	2.65	3.70	3.25	2.70	2.20	1.80	1.30
18.0	4.20	3.15	2.50	3.55	3.10	2.55	2.15	1.75	1.30
20.0	3.75	2.90	2.35	3.45	3.00	2.45	2.05	1.65	1.25
22.0	3.10	2.70	2.25	3.20	2.85	2.35	2.00	1.60	1.25
24.0	2.45	2.55	2.15	2.55	2.70	2.25	1.90	1.50	1.20
26.0	1.95	2.10	2.05	2.05	2.20	2.15	1.85	1.45	1.15
28.0	1.50	1.65	1.75	1.60	1.75	1.85	1.70	1.35	1.15
30.0	1.10	1.20	1.30	1.20	1.35	1.45	1.55	1.30	1.10
32.0	0.75	0.85	0.95	0.85	0.95	1.05	1.35	1.25	1.05
34.0	0.50	0.55	0.65	0.55	0.65	0.75	1.05	1.15	1.00
36.0						0.50	0.80	0.85	1.00
38.0							0.55	0.70	0.85
40.0								0.55	0.65
42.0									
44.0									
46.0									

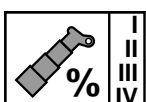

I
II
III
IV

100				100				100				
100				100				100				
75				100				100				
75				100				100				

Hubhöhen
Lifting heights
Hauteurs de levage
Alturas de elevación

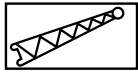
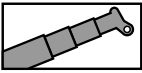

8.9t

DIN/ISO

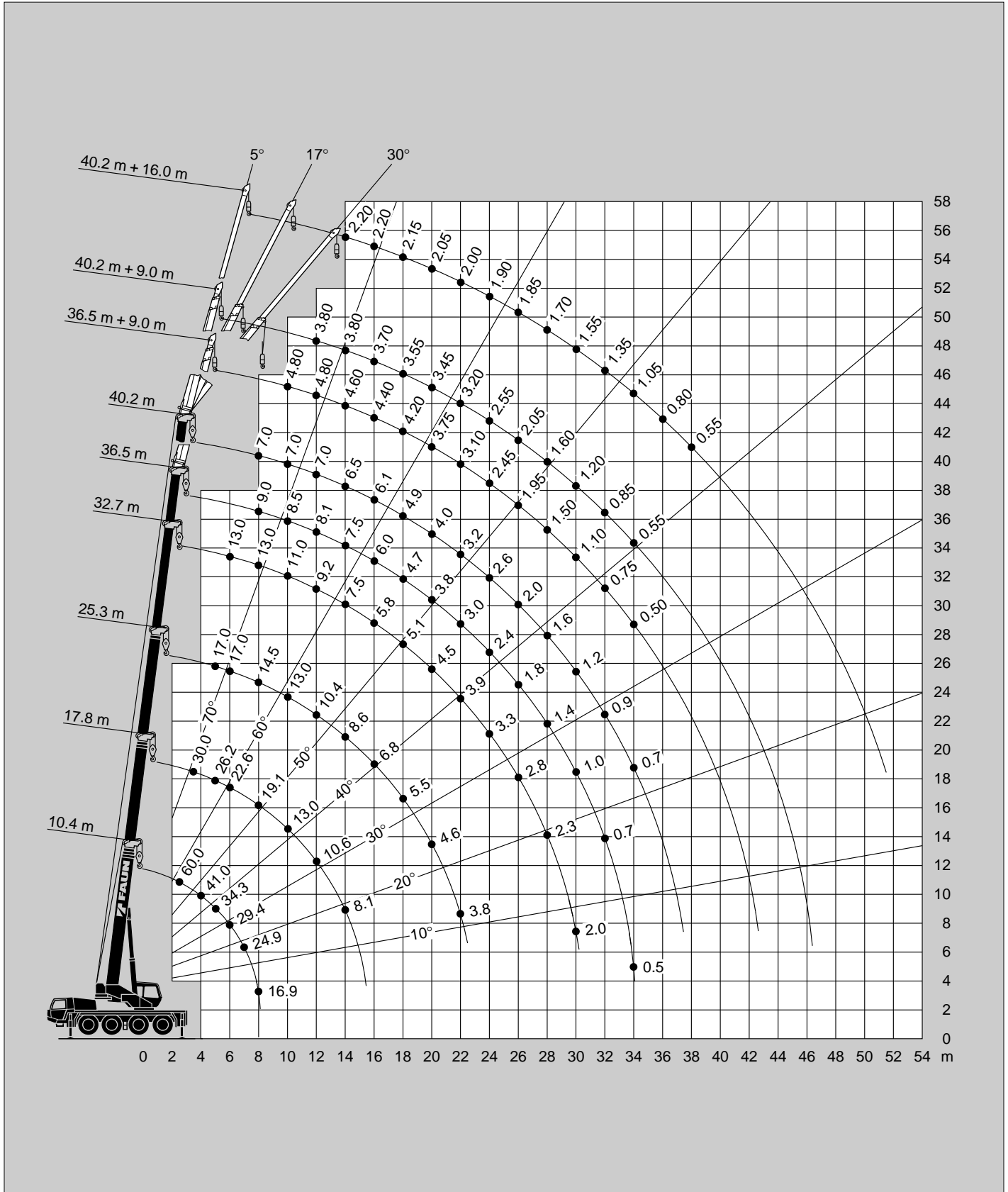

**) Nach hinten, mit Zusatzausrüstung

**) Over rear, with additional equipment

**) A l'arrière, avec équipement supplémentaire

**) Sobre la parte trasera, con equipo adicional

Anmerkungen zu den Traglasttabellen

Die Tragfähigkeiten im Festigkeitsbereich basieren auf DIN 15018 Blatt 2 und Blatt 3 und F.E.M.

Die Tragfähigkeiten im Standsicherheitsbereich entsprechen DIN 15019 Teil 2 / ISO 4305 und prEN 13000.

Die zulässige Windgeschwindigkeit beträgt maximal 15 m/sec.

Die Tragfähigkeiten sind in metrischen Tonnen angegeben.

Das Gewicht des Lasthakens bzw. der Hakenflasche und weiterer Anschlagmittel ist von der Tragfähigkeit abzuziehen.

Die Tragfähigkeiten für den Teleskopausleger gelten nur bei demontierter Spitze.

Die Ausladung ist der horizontale Abstand von Mitte Drehkranz bis Mitte freihängender, nicht schwingender Last.

Tragfähigkeitsänderungen vorbehalten.

Obige Angaben dienen nur zur Information. Die Bedienungsanleitungen müssen zu Rate gezogen werden, bevor die Maschine in Betrieb genommen wird. Alle hier gemachten Angaben beziehen sich auf die Standard-Ausführung. Jegliche Ausrüstungsveränderungen können die angegebenen Werte beeinflussen.

Remarks concerning the load charts

The load capacities rated for strength are based on DIN 15018, p. 2 & 3, and F.E.M.

The load capacities rated for tilt-over stability comply with DIN 15019, part 2 / ISO 4305, and prEN 13000.

Maximum allowable wind speed for crane operation is 15 m/sec.

The load capacities shown are in metric tons.

The weight of hook or bottom block and of any other load handling devices shall be considered part of the load and must be deducted from the rated capacities.

Load capacities rated for the telescopic beam are valid only for condition with fly jib removed.

Working radius is the distance from the centre of the slewing gear to the centre of freely suspended and non-oscillating load.

Modifications of load capacity ratings are reserved.

Notes and ratings stated above are for basic information only and the operator's manual must be consulted before operating this machine. All data stated herein refer to a standard machine. Any change of the machine's equipment may affect those rated values.

Remarques relatives aux tableaux des charges

Les forces de levage sont conformes aux normes DIN 15018, p. 2 et 3, et F.E.M.

Les forces de levage dans la partie de stabilité au renversement sont conformes aux normes DIN 15019, chap. 2 / ISO 4305 et prEN 13000.

La grue peut travailler aux vitesses de vent allant jusqu'à 15 m/s.

Les forces de levage sont données en tonnes métriques.

Le poids du crochet-moufle et de tous les accessoires d'élingage font partie de la charge et sont à déduire des charges indiquées.

Les forces de levage indiquées pour la flèche télescopique s'entendent flèche déposée.

Comme portée, on entend la distance horizontale du centre de la couronne de rotation au centre de la charge librement suspendue et non oscillante.

Sauf modification de forces de levage.

Les données ci-dessus servent à titre d'information. Avant la mise en marche de la grue il est conseillé d'étudier les instructions de service. Toutes les données indiquées ci-dessus se réfèrent à la machine de base. Tout changement de l'équipement de la grue peut influencer ces valeurs.

Notas relativas a los graficos de carga

En cuanto a los datos referentes a resistencia, las capacidades de carga están baseados sobre las normas DIN 15018, pág. 2 y 3, y F.E.M.

En cuanto a los datos referentes a estabilidad anti-vuelco, las capacidades de carga están baseados sobre las normas DIN 15019, Cap. 2 / ISO 4305 y prEN 13000.

La velocidad anemométrica max. admisible es de 15 m/seg.

Las capacidades de carga indicadas en las tablas corresponden a toneladas métricas.

Hay que deducir los pesos del gancho o del motón y de otros dispositivos para fijación de cargas de los valores de capacidad de carga indicados en las tablas.

Las capacidades de carga referentes a la pluma telescópica rigen solamente si la punta está desmontada.

Como alcance se entiende la distancia horizontal desde el centro de la corona de rodaduras hasta el centro de la carga suspendida libremente y no oscilante.

Salvo modificación de capacidades de carga.

Los datos arriba indicados sirven solamente para su información. Hay que leer las instrucciones para el uso antes de la puesta en servicio de la máquina. Todos los datos mencionados en las presentes tablas rigen para los modelos standard. Cualquier modificación del equipo montado puede dar lugar a modificaciones de aquellos valores.

Tragfähigkeiten
Lifting capacities
Capacités de levage
Capacidades de elevación

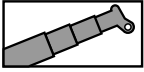

12.1t*

DIN/ISO

m	10.4 m	14.1 m	17.8 m	17.8 m	17.8 m	25.3 m	25.3 m	25.3 m	32.7 m	32.7 m	36.5 m	40.2 m
	2.5	60.0**										
3.0	50.0	30.0										
3.5	44.8	30.0	20.0	30.0	13.0							
4.0	41.0	30.0	20.0	29.0	13.0							
4.5	37.0	30.0	20.0	27.5	13.0							
5.0	34.3	30.0	20.0	26.2	13.0	13.0	17.0	11.8				
6.0	29.8	29.0	20.0	22.6	13.0	13.0	17.0	11.8	13.0	9.5		
7.0	25.3	24.5	20.0	19.8	13.0	13.0	15.8	11.8	13.0	9.2		
8.0	16.9	21.1	20.0	17.5	13.0	13.0	14.5	11.8	13.0	8.8	9.0	7.0
9.0		17.4	17.7	15.6	13.0	13.0	13.3	11.4	12.0	8.5	8.8	7.0
10.0		14.5	14.8	14.1	13.0	13.0	12.0	11.0	11.0	8.1	8.5	7.0
11.0		12.4	12.6	12.0	13.0	12.6	10.9	10.5	10.1	7.7	8.3	7.0
12.0			10.8	10.2	12.1	12.0	9.8	10.1	9.2	7.4	8.1	7.0
14.0			8.2	7.6	9.5	9.3	8.0	8.8	7.8	6.7	7.6	6.5
16.0						7.4	6.1	7.7	6.7	5.8	6.5	6.1
18.0						5.9	4.7	6.6	5.5	5.1	5.6	5.3
20.0						4.8	3.7	5.5	4.4	4.5	4.6	4.6
22.0						4.0	2.8	4.6	3.6	4.0	3.8	4.0
24.0									2.9	3.6	3.1	3.3
26.0									2.3	3.2	2.5	2.7
28.0									1.8	2.9	2.0	2.2
30.0									1.4	2.5	1.6	1.8
32.0											1.3	1.5
34.0											1.0	1.2
36.0												0.9

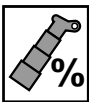

I
II
III
IV

I	0	50	50	100	0	50	100	0	100	0	100	100
II	0	0	50	0	33	50	100	67	100	100	100	100
III	0	0	0	0	33	50	0	67	50	100	75	100
IV	0	0	0	0	33	50	0	67	50	100	75	100

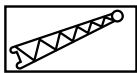
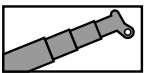

12.1t*

DIN/ISO

m	36.5 m + 9.0 m			40.2 m + 9.0 m			40.2 m + 16.0 m		
	5°	17°	30°	5°	17°	30°	5°	17°	30°
10.0	4.80			3.80					
11.0	4.80			3.80					
12.0	4.80	4.00	3.00	3.80	3.40		2.20		
14.0	4.60	3.75	2.85	3.80	3.40	2.80	2.20	1.80	
16.0	4.40	3.45	2.65	3.70	3.25	2.70	2.20	1.80	1.30
18.0	4.20	3.15	2.50	3.55	3.10	2.55	2.15	1.75	1.30
20.0	3.75	2.90	2.35	3.45	3.00	2.45	2.05	1.65	1.25
22.0	3.40	2.70	2.25	3.30	2.85	2.35	2.00	1.60	1.25
24.0	3.10	2.55	2.15	3.20	2.70	2.25	1.90	1.50	1.20
26.0	2.60	2.40	2.05	2.70	2.55	2.15	1.85	1.45	1.15
28.0	2.10	2.25	1.95	2.20	2.35	2.05	1.70	1.35	1.15
30.0	1.65	1.80	1.90	1.75	1.90	1.95	1.55	1.30	1.10
32.0	1.30	1.40	1.50	1.40	1.50	1.60	1.45	1.25	1.05
34.0	0.95	1.05	1.15	1.05	1.15	1.25	1.35	1.15	1.00
36.0	0.70	0.80	0.80	0.80	0.90	0.95	1.25	1.10	1.00
38.0	0.45	0.50	0.50	0.55	0.60	0.65	1.00	1.05	0.95
40.0					0.40	0.40	0.80	0.90	0.90
42.0							0.60	0.70	0.80
44.0							0.45	0.50	0.60
46.0									0.40

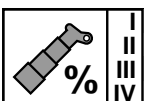

I
II
III
IV

I	100			100			100		
II	100			100			100		
III	75			100			100		
IV	75			100			100		

Hubhöhen
Lifting heights
Hauteurs de levage
Alturas de elevación

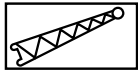
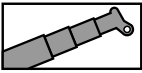

12.1 t*

DIN/ISO

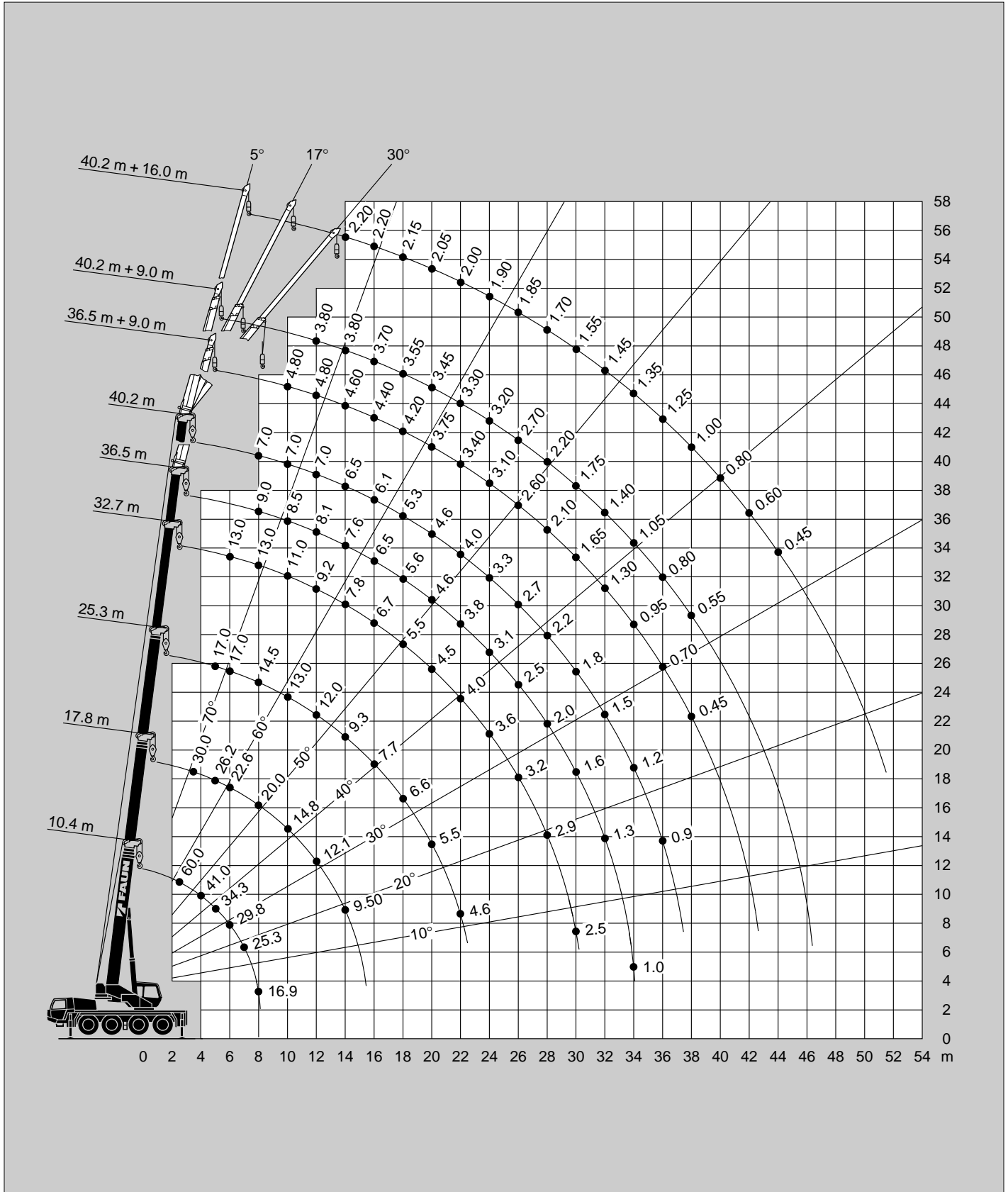

*) Gegen Mehrpreis
**) Nur nach hinten

*) Against extra charge
**) Only over rear

*) Contre supplément de prix
**) A l'arrière

*) Con suplemento de precio
**) Sobre la parte trasera

Tragfähigkeiten am Teleskopausleger
 Lifting capacities on telescopic boom
 Capacités de levage sur la flèche télescopique
 Capacidades de elevación con la pluma telescópica

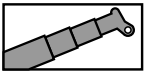

12.1t*

DIN/ISO



→ m	10.4 m	17.8 m
3.0	21.0	
3.5	19.2	13.0
4.0	17.5	13.0
4.5	15.2	13.0
5.0	13.2	12.4
6.0	10.2	10.2
7.0	8.1	8.5
8.0	6.6	7.2
9.0		6.0
10.0		5.0
11.0		4.3
12.0		3.7
14.0		2.7

%	I	II	III	IV
	0	0	0	0
	0	0	33	33
	0	0	33	33
	0	0	33	33

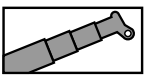

12.1t*

DIN/ISO

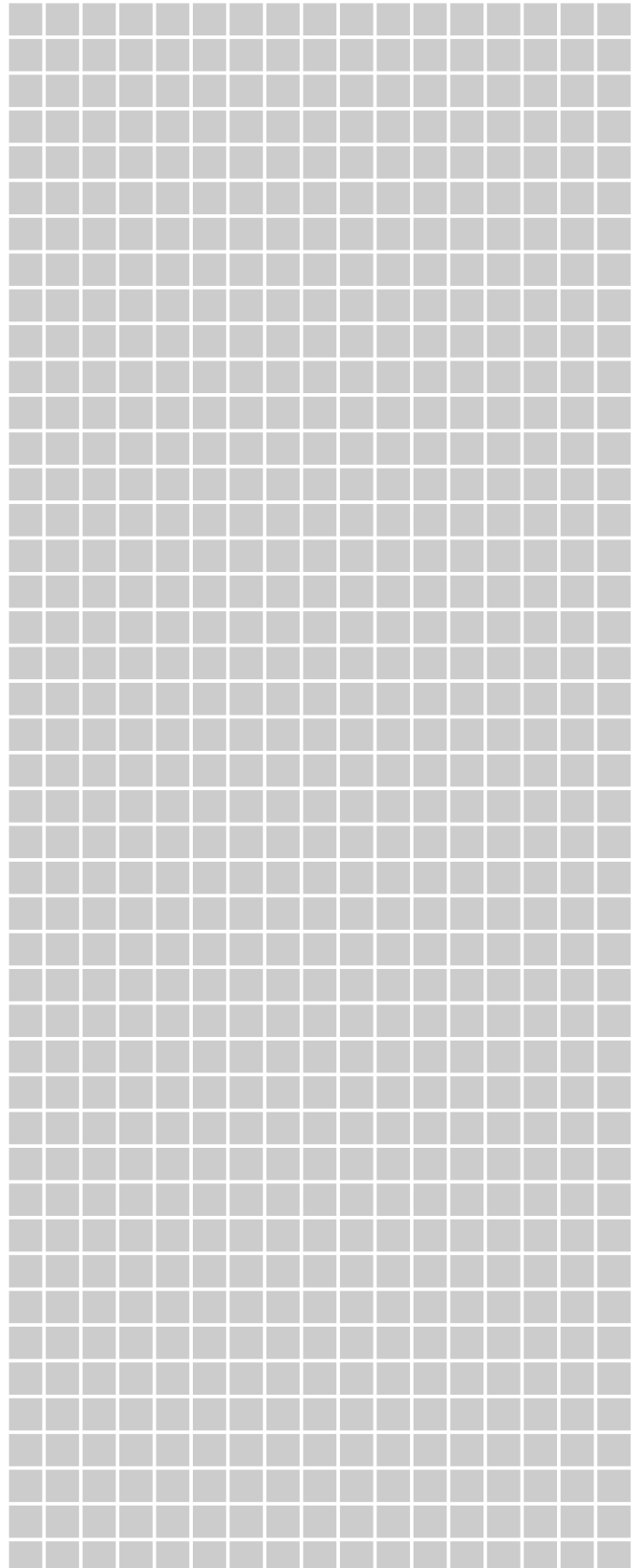
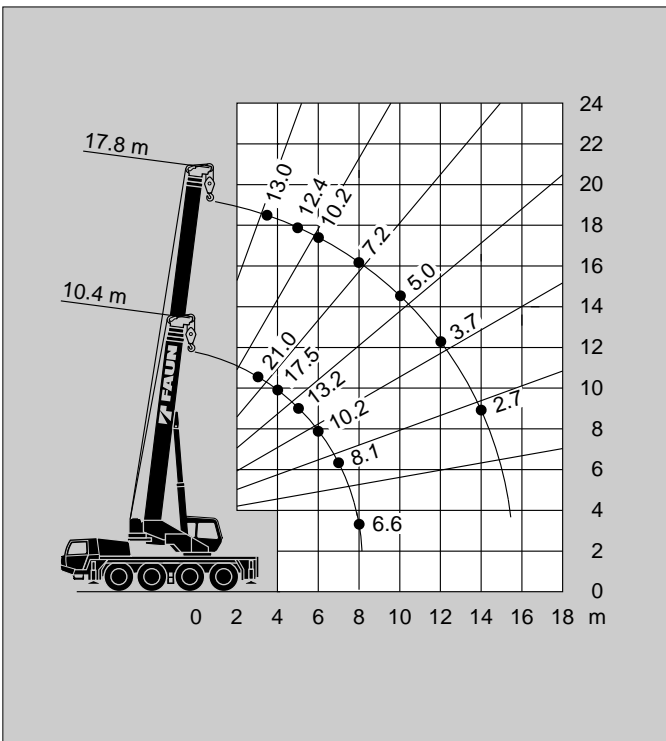

Gewichte / Geschwindigkeiten
Weights / Working speeds
Poids / Vitesses
Pesos / Velocidades de trabajo

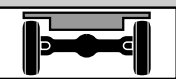
	Achse / Axle Essieu / Eje	1	2	3	4	Gesamtgewicht / Total weight Poids total / Peso total
	(t)	12	12	12	12	48*

* Incl. 13,2 t Gegengewicht, Bereifung 16.00 R 25, 9 m / 16 m Gitterspitze, 32 t Hakenflasche, 6 t Hakengeschirr, Antrieb 8 x 6.

* Incl. 13.2 t counterweight, tyres 16.00 R 25, 9 m / 16 m folding swingaway, 32 t hook block, 6 t swivel hook, drive 8 x 6.



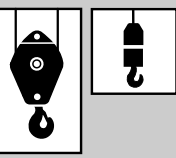

* Incl. de 13,2 t contrepoids, pneus 16.00 R 25, 9 m / 16 m extension treillis, 32 t moufle, 6 t elingues, entraînement 8 x 6.





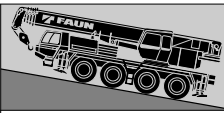

* Incl. contrapeso de 13,2 t, neumáticos 16.00 R 25, 9 m / 16 m plumin articulado, gancho de 32 t, 6 t gancho de bola, tracción 8 x 6.

	Traglast / Lifting capacity / Force de levage / Capacidad de elevación	Rollen / Sheaves Pulies / Poleas	Stränge / Parts of line Brins / Ramales de cable	Gewicht / Weight Poid / Peso
	50 t *	5	11	600 kg
	50 t	5	11	600 kg
	32 t *	3	7	300 kg
	32 t	3	7	300 kg
	12,5 t	1	3	170 kg
	6 t	-	1	150 kg

* Doppelhaken
* Rams horn
* Moufle avec crochet marin
* Gancho doble

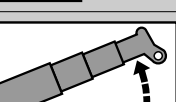

	1	2	3	4	5	6	7	8	9	10	11	12	13	14	15	16	R1	R2		
km/h 	6	7	8	10	11	13	17	20	25	30	36	43	51	61	76	80	6	8		46%
km/h 	-	-	-	-	-	-	-	-	-	-	-	-	-	-	-	-	-	-	-	-
	14.00 R 25																			

V+ 	Stufenlos Infinitely variable Progressivement variable Infinitamente variable	Seil Rope Câble Cable	Max. Seilzug Max. single line pull Effort maxi au brin simple Trio máximo por ramal
	0 - 130 m/min für einfachen Strang single line au brin simple ramal simple	16 mm / 180 m	52 kN
	0 - 70 m/min für einfachen Strang single line au brin simple ramal simple	14 mm / 140 m	39 kN
	0 - 2 min ⁻¹		
	-2° - +82° ca. 33 s approx. 33 s env. 33 s aproximadamente 33 s		
	10.4 m - 40.2 m ca. 90 s approx. 90 s env. 90 s aproximadamente 90 s		

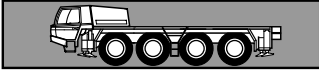

Rahmen Verwindungs- und biegesteife Kastenkonstruktion.

Abstützung 4-Punkt vollhydraulisch, Betätigung links und rechts am Fahrgestell.

Motor (EURO 2) 6 Zylinder Mercedes Benz wassergekühlt, OM 501 LA, 260 kW (354 PS) bei 1800 U/min, Drehmoment 1730 Nm (176 kpm) bei 1080 U/min.

Getriebe ZF-Schaltgetriebe 16 S 151 mit Easy-Shift-Schaltung und 16 Vorwärts- und 2 Rückwärtsgängen.

Achsen

1. + 2. Achse: gelenkt, nicht angetrieben.
3. + 4. Achse: gelenkt, angetrieben mit Differentialsperren.

Antrieb 8 x 4 (8 x 6*)

Federung Hydro-pneumatisch, hydraulisch blockierbar mit Niveauregulierung.

Bremsen Betriebsbremse: Zweikreis-Druckluft-Bremsanlage. Feststellbremse: Federspeicher an der 2., 3. und 4. Achse. Dauerbremse: Konstantdrosselanlage und Auspuffklappenbremse, Wirbelstrombremse*.

Bereifung 8 fach 14.00 R25 (16.00 R25*)

Lenkung Aus der Fahrgestellkabine: Servocom-2-Kreis-Hydrolenkung. Mechanische Lenkung der Vorderachsen, hydraulisch unterstützt, mit Notlenkpumpe. Optional hydrostatische Lenkung aus der Krankabine*.

Fahrerhaus Zweimann-Fahrerhaus in Stahl-Kunststoff-Verbundkonstruktion, Sicherheitsverglasung, luftgefederte Sitze und motorabhängige Warmwasserheizung. Kontroll- und Bedienungselemente für den Fahrbetrieb.

Elektrische Anlage 24 Volt Gleichstrom, 2 Batterien. Nach der EG-Regulation.

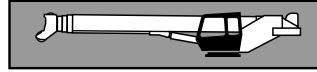

Rahmen Verwindungssteife Schweißkonstruktion. Einreihige außenverzahnte Kugeldrehverbindung zwischen Fahrgestell und Oberwagen, um 360° unbegrenzt drehbar.

Motor (EURO 2) 4 Zylinder Mercedes Benz wassergekühlt, OM 904 LA, 90 kW (122 PS) bei 2300 U/min. (Motorleistung nach DIN 6271).

Hydrauliksystem Diesel-hydraulisch mit 3-Kreis-Hydraulik, 1 leistungsgeregelte Axialkolbendoppelpumpe (hydraulisch verstellbar) und eine Zahnrad-Doppelpumpe.

Steuerung Zwei 4-fach Kreuzsteuerhebel mit hydraulischer Vorsteuerung.

Wippwerk 1 Differentialzylinder mit angebautem Senkbremseventil.

Drehwerk Konstantmotor, zweistufiges Planetengetriebe mit fußbetätigter Betriebsbremse und mit Feststellung. Drehgeschwindigkeit stufenlos von 0 - 2 U/min.

Hubwerk Axialkolben-Konstantmotor, Hubwerkstrommel mit eingebautem Planetengetriebe und federbelasteter Haltebremse mit integriertem Freilauf.

Teleskopausleger Fünfteiliger, kastenförmiger Teleskopausleger, bestehend aus einem Grundausleger und 4 Teleskopteilen, hydraulisch unter Teillast teleskopierbar. 10.4 m - 40.2 m lang.

Auslegerverlängerung* Teleskop-Spitzenausleger, seitlich klappbar, 9.0 m / 16.0 m lang, unter 5°, 17° und 30° abwinkelbar.

Gegengewicht 8.9 t teilbar, Betätigung erfolgt aus der Krankabine. 13.2 t* teilbar.

Krankabine Großräumige Krankabine in Stahlblechausführung mit Sicherheitsverglasung seitlich links am Oberwagen, verstellbarem hydraulisch gedämpften Sitz und motorabhängiger Warmwasserheizung. Kontroll- und Bedienungselemente für den Kranbetrieb. Optional Verfahrbarkeit vom Oberwagen* und Abstützbetätigung*.

Sicherheitseinrichtungen Sicherheitsventile gegen Rohr- und Schlauchbruch, Windenendschalter, Windendrehmelder, Lastmomentbegrenzung und Hubendschalter.

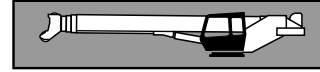
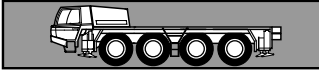

Frame Box-type, torsion resistant, welded construction.

Outriggers Four point, fully hydraulic. Controls on both sides of carrier.

Engine (EURO 2) 6 cylinder Mercedes Benz, water-cooled, OM 501 LA, 260 kW (354 HP) at 1,800 rpm, torque 1730 Nm (176 kpm) at 1,080 rpm.

Transmission ZF 16 S 151 with Easy-Shift operation, providing for 16 forward and 2 reverse gears.

Axles

1 & 2: steering, not driven
3 & 4: steering, driven, with differential locks

Drive 8 x 4 (8 x 6*)

Suspension Hydro-pneumatic, hydraulically blockable, with levelling .

Brake system Service brakes: dual circuit compressed air system. Parking brake: spring loaded type acting on 2nd, 3rd and 4th axles. Auxiliary brake: eddy-current brake.

Wheels 8 ea., 14.00 R25 (16.00 R25*)

Steering System From carrier cab: Servocom 2-circuits hydraulic steering system. Mechanical steering of front axles with hydraulic assistance, with emergency steering pump. Optional equipment: Hydrostatic steering controlled from the crane cab*.

Carrier cab Two man full width cab of composite (steel sheet metal and fibre-glass) structure, with safety glass, cushioned seats, motor dependent warm-water heater. Complete controls and instrumentation for road travel.

Electrical system 24 V D.C., 2 batteries, according to E.E.C. directives.

Frame Torsion-resistant all-welded structure of high strength steel. Connected to carrier by single-row ball slewing ring with external gearing for 360° continuous rotation.

Crane engine (EURO 2) 4 cylinder Mercedes Benz, water-cooled, OM 904 LA, 90 kW (122 HP) at 2,300 rpm (power rating as per DIN 6271).

Hydraulic system Three circuit diesel hydraulic system with 1 double axial piston variable displacement pump (hydraulically adjustable with cross-sensing) and 1 double gear pump.

Steering system Two four-direction joysticks with hydraulic precontrol.

Boom hoist 1 differential cylinder with integral holding valve.

Slewing gear Constant displacement motor with two-stage planetary gear with a foot actuated service brake and a parking brake. Slewing speed infinitely variable: 0 - 2.0 rpm.

Main winch Axial piston constant displacement motor, hoist drum with planetary reduction and spring-loaded, multiple disc brake with integrated free wheeling.

Telescopic main boom Five section box type construction consisting of 1 base section and 4 telescoping sections. All sections hydraulically extendable under load. 10.4 - 40.2 m long.

Boom extension* Swing-around, telescopic boom extension 9.0 - 16.0 m long, offsets 5°, 17° and 30°.

Counterweight 8.9 tons, divisible, operated from the crane operator's cab; 13.2 t* divisible.

Crane cab Spacious all-steel comfortable panoramic cab with special tinted safety glass, hydraulically cushioned and adjustable seat, independent hot-air heater. Optional controls and instrumentation for crane operation and on-site travelling* and outrigger operation*.

Safety devices Load moment device (LMD). Safety valves against pipe and hose rupture, holding valves on hydraulic cylinders, lower limit switch on main winch and drum turn indicator.



Châssis Construction mécano-soudée, en forme de caisson, résistante aux flexions et aux torsions.

Calage Commande complètement hydraulique, à 4 points, à gauche et à droite du châssis.

Moteur (EURO 2) Mercedes Benz de 6 cylindres, refroidi par eau, modèle OM 501 LA, de 260 kW (354 CV) à 1800 tr./mn. Couple 1730 Nm (176 kpm) à 1080 tr./mn.

Boîte de vitesses mécanique, marque ZF, type 16 S 151, avec commande "Easy-shift" et 16 vitesses avant et 2 arrières.

Essieux

1er et 2ème: directeurs, non-entraînés
3ème et 4ème: moto-directeurs avec blocages de différentiels

Transmission 8 x 4 (8 x 6*)

Suspension hydro-pneumatique, avec blocage hydraulique et réglage de niveau.

Freins Frein de service: système à air comprimé, à double circuit. Frein de stationnement: avec accumulateurs à ressort agissant sur le 2ème, 3ème et 4ème essieu. Frein continu: frein sur échappement et étrangleur. Ralentisseur électromagnétique sans usure.*

Pneus 8 roues de 14.00 R25 (16.00 R25*)

Direction A partir de la cabine du châssis: Système hydraulique Servocom à 2 circuits. Direction mécanique des essieux AV avec assistance hydraulique, et avec pompe de direction de secours. Sur demande: Direction hydrostatique commandée à partir de la cabine du grutier*.

Cabine du conducteur Cabine bi-place, construction en matière combinée, avec vitrage en verre de sécurité, sièges à ressort et amorti hydrauliquement et avec chauffage à eau relié au moteur. Avec instruments de contrôle et de conduite.

Système électrique 24 V courant continu, alternateur, éclairage conforme au code de la route de la C.E.E.

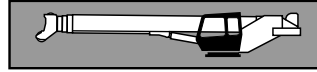

Plate forme Construction mécano-soudée, résistant à la torsion. Couronne d'orientation avec denture extérieure entre châssis et superstructure permettant une rotation illimitée à 360°.

Moteur (EURO 2) Mercedes Benz de 4 cylindres, refroidi par eau, modèle OM 904 LA, de 90 kW (122 CV) à 2300 tr./mn. (Puissance selon DIN 6271).

Système hydraulique Diesel-hydraulique, avec 3 circuits, comprenant 1 double pompe à pistons axiaux à régulation de puissance (réglable hydrauliquement, système cross-sensing) et 1 double pompe à engrenages.

Commande 2 manipulateurs à commande en croix, assistés hydrauliquement.

Mécanisme de relevage Vérin différentiel muni de clapet de sécurité.

Mécanisme de rotation Moteur hydraulique avec entraînement planétaire à 2 gammes. Frein de service actionné par l'intermédiaire d'une pédale et frein de stationnement. Vitesse de rotation 0 à 2.0 tr/min.

Mécanisme de levage Moteur hydraulique, tambour de levage avec boîte planétaire incorporée, frein d'arrêt à disques multiples à ressort, libéré lors du levage.

Flèche télescopique 1 élément de base et 4 éléments télescopiques, télescopables hydrauliquement sous charge. Flèche en forme de caisson. Longueur de flèche: 10,4 m à 40,2 m.

Rallonge de flèche* De 9,0 m à 16,0 m, rabattable latéralement et inclinable à 5°, 17° et 30°.

Contrepoids 8.9 t divisible, commandé à partir de la cabine du grutier; 13.2 t* divisible.

Cabine de conduite spacieuse, en acier, avec vitrage de sécurité, siège suspendu sur ressort, amorti hydrauliquement et réglable. Chauffage à eau chaud dépendant du moteur. Tableau de bord avec instruments de contrôle et de conduite. En option, déplacement de la grue et calage à partir de la cabine du grutier.

Dispositifs de sécurité Contrôleur électronique de charge (CEC), clapets anti-retour contre rupture des conduites et flexibles, fin de course du treuil pour câble de levage et indicateur du nombre de tours sur tambour de treuil.

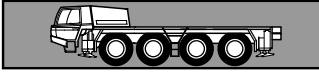

Chasis Construcción de acero soldado resistente a la torsión y a la flexión.

Estabilizadores de 4 puntos, enteramente hidráulicos, accionados desde los lados izquierdo y derecho del chasis.

Motor (EURO 2) de 6 cilindros, marca Mercedes-Benz, refrigerado por agua, tipo OM 501 LA, 260 kW (354 C.V.) a 1800 rpm, par 1730 Nm (176 kpm) a 1080 rpm.

Transmisión mecánica ZF, tipo 16 S 151, con mando "Easy-shift" y 16 velocidades de avance y 2 marchas atrás .

Ejes

1° y 2°: dirigibles, no propulsados

3° y 4°: dirigibles, propulsados, con bloqueos de diferencial

Tracción 8 x 4 (8 x 6*)

Suspensión Hidro-neumática, con bloqueo hidráulico y ajuste de nivelación.

Frenos Freno de servicio: Sistema de aire comprimido, de dos circuitos.

Freno de estacionamiento: con acumuladores a resorte en los ejes 2°, 3° y 4°.

Freno continuo: Sistema de estrangulación constante y freno con válvula de escape, retardador*.

Neumáticos 8, de 14.00 R25 (16.00 R25*)

Dirección accionada desde la cabina del chasis: Dirección hidráulica Servocom, de doble circuito. Dirección mecánica de los ejes anteriores con asistencia hidráulica y con bomba de emergencia. Según deseo: Dirección hidrostática controlada desde la cabina superestructura*.

Cabina del chasis portante para dos hombres, hecha de combinación de acero y de planchas de fibras de vidrio, cristales de seguridad, sillones con suspensión a aire comprimido, y calefacción por agua calentada, dependiente del motor. Elementos de control y de mando para el funcionamiento de la grúa.

Sistema eléctrico de 24 V C.C., 2 baterías, conforme a las normas C.E.

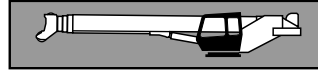

Superestructura Estructura de acero toda soldada, resistente a la torsión, corona de giro de una fila de bolas, con dientes externos para rotación continua de 360°.

Motor (EURO 2) de 4 cilindros, marca Mercedes-Benz, refrigerado por agua, tipo OM 904 LA, 90 kW (122 C.V.) a 2300 rpm (potencia del motor según DIN 6271).

Sistema hidráulico Diesel-hidráulico de 3 circuitos, bomba doble de pistones axiales, de caudal variable y una bomba doble de engranajes.

Controles 2 palancas de control infinito de tipo universal (joy-stick) para movimientos simultáneos.

Elevación de la pluma Cilindro hidráulico de doble efecto con válvula de retención integrada.

Sistema de giro Motor de desplazamiento constante con engranaje planetario de dos etapas, freno de servicio que se controla con el pie y freno de estacionamiento. Velocidad de giro infinitamente variable: 0 - 2.0 rpm.

Cabrestante Motor de pistones axiales de desplazamiento constante, tambor de elevación con reducción planetaria y freno multidisco cargado por resortes.

Pluma principal telescópica Construcción de tipo de caja, con un tramo de base y cuatro tramos telescópicos. Todos los tramos se extienden hidráulicamente bajo carga, longitud de 10.4 a 40.2 m.

Prolongación de la pluma* Prolongación de la pluma telescópica, abatible lateralmente, de 9.0 - 16.0 m de longitud, angulable a 5°, 17° y 30°.

Contrapeso Total de 8.9 ton divisible. (13.2* ton divisible). Accionado de la cabina superestructura.

Cabina de la grúa Cabina panorámica, espaciosa y confortable, toda de acero, con lunas especiales de seguridad, sillón regulable amortiguado hidráulicamente y calefacción por agua caliente independiente. Controles y instrumentos para operación de la grúa y desplazamiento en la obra. Opcionalmente, conducción desde la superestructura y accionamiento de los estabilizadores.



Dispositivos de seguridad Dispositivo de momento de carga (LMD). Válvulas de seguridad contra rotura de tuberías y latiguillos, válvulas de retención en los cilindros hidráulicos, interruptor de límite carrera de bajada en el cabrestante principal e indicador de vuelta del tambor.

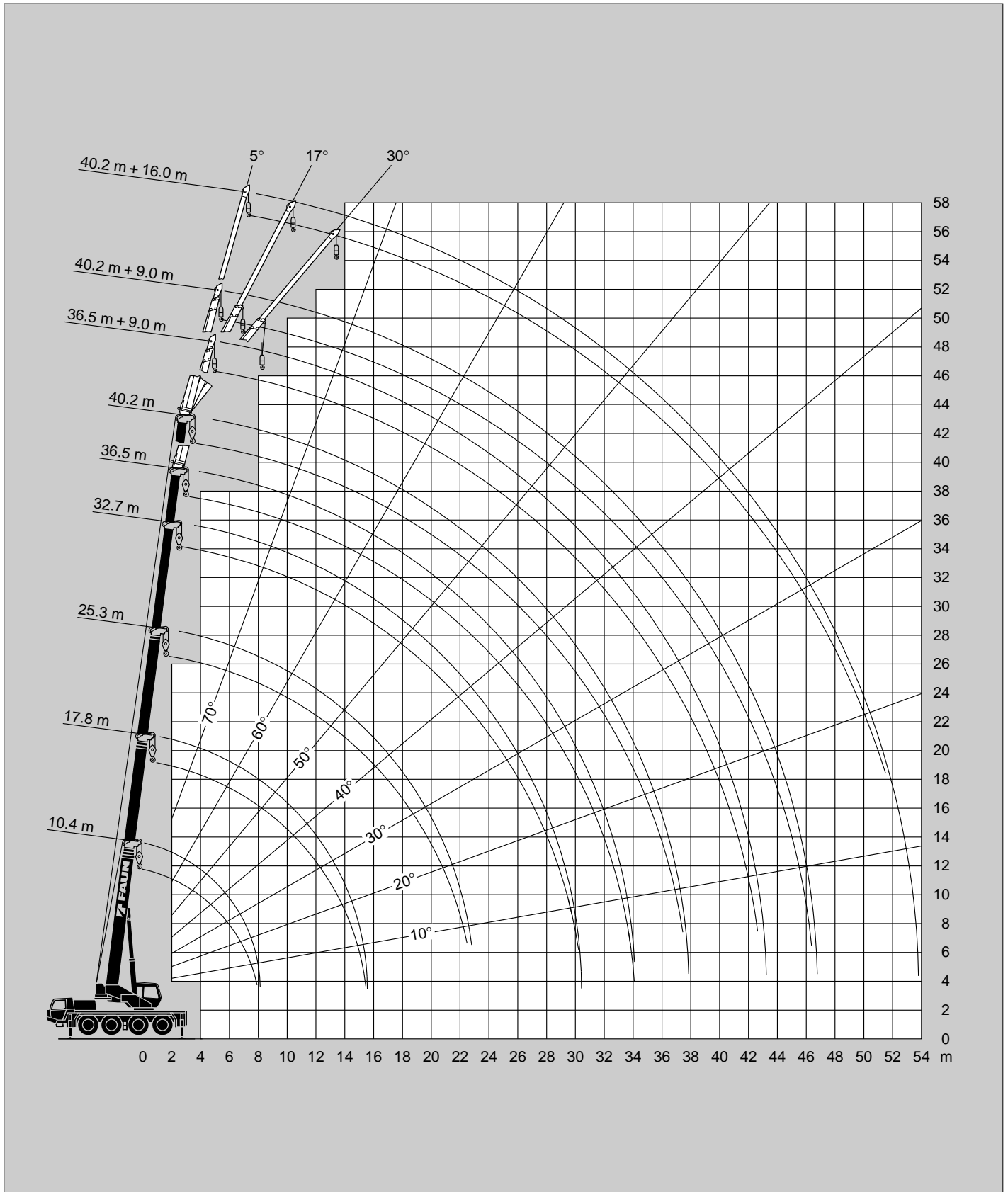

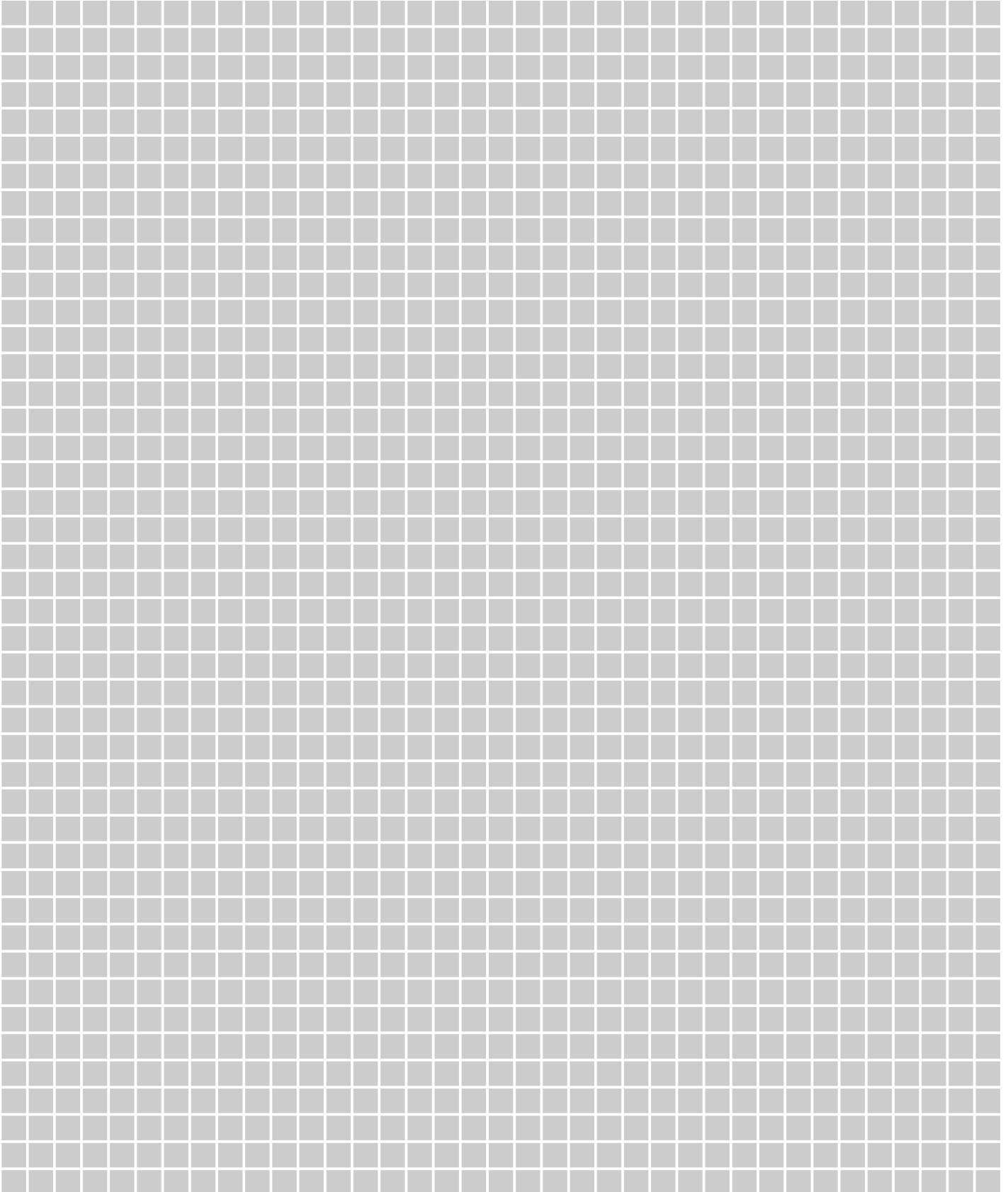
Hakenhöhen / Kopfhöhen
 Hook height / Tip height
 Hauteurs sous crochet / Hauteurs tête de flèche
 Altura del gancho / Altura de la punta





24

	D	→	00 49	
A	B	CH	DK	F
GB	I	N	NL	P
E	07  49	S	00 949	

	(0) 91 23 95 50 
	(0) 17 18 11 43 24 

	(0) 91 23 18 51 55
	(0) 91 23 18 52 19
	(0) 91 23 30 85

	http://www.tadanofaun.de
	http://www.f aun.de
	e-mail: info@tadanofaun.de

	 SERVICE  
---	---

	Spare parts / Service department
	e-mail: spareparts@tadanofaun.de
	e-mail: service@tadanofaun.de